



# Protecting Yourself During a Dirty Bomb Response

An Awareness Level Training Tool for Skilled Support Personnel





# How to Use this Training Tool

- This training tool is an awareness-level health and safety resource for “skilled support personnel” who will participate in a dirty bomb response.
- This tool will help workers understand at an awareness level: what a dirty bomb is, the basics of radiation, how to protect against radioactive contamination and other hazards associated with a dirty bomb response.
- Trainers may use this tool to aid in the development of a dirty bomb awareness level course or other awareness level materials (fact-sheets, table-top activities, etc.)



## Advanced/Additional Training Required for Those Involved in a Dirty Bomb Response

- This training tool does not replace the radiation-specific training, additional duty specific training or PPE specific training requirements.
- Regardless of work scope, there are many topics covered in this awareness training tool that have corresponding OSHA standards which must be met in order to safely and legally perform associated job duties.

***Contact the NIEHS National Clearinghouse for Worker Safety and Health Training for information for advanced training on dirty bomb response, 202-331-7733.***



# Employer and Worker Responsibilities

Employers and workers have responsibilities under the OSH Act.

- The Occupational Safety and Health Act requires employers provide a safe and healthful workplace free of recognized hazards and follow OSHA standards. Employers' responsibilities also include providing training, medical examinations and recordkeeping.
- Workers must follow the employer's safety and health rules and wear or use all required gear and equipment; follow safe work practices for their job, as directed by their employer; report hazardous conditions to a supervisor; and report hazardous conditions to OSHA if employers do not fix them.



## Module 1

# Radiological Dispersion Device (RDD) “Dirty Bomb” Awareness





## What is an RDD?

Often referred to as a dirty bomb, an RDD uses conventional explosives or some other mechanism to spread radioactive contamination.

### Characteristics of RDDs:

- A terrorist event
- Low technology
- Low cost to make
- Wide range of usable radioactive materials
- Contamination restricts use of area until it can be decontaminated
- Cleanup problem
- Economic impact
- Psychological impact
- Spread fear (perceived danger)



Cesium filled package uncovered in Moscow's Izmaylovsky Park.



## An RDD is Not a Nuclear Device

A nuclear device or Improvised Nuclear Device (IND) releases an enormous amount of energy (atomic bomb) while an RDD releases a comparatively small amount of energy.

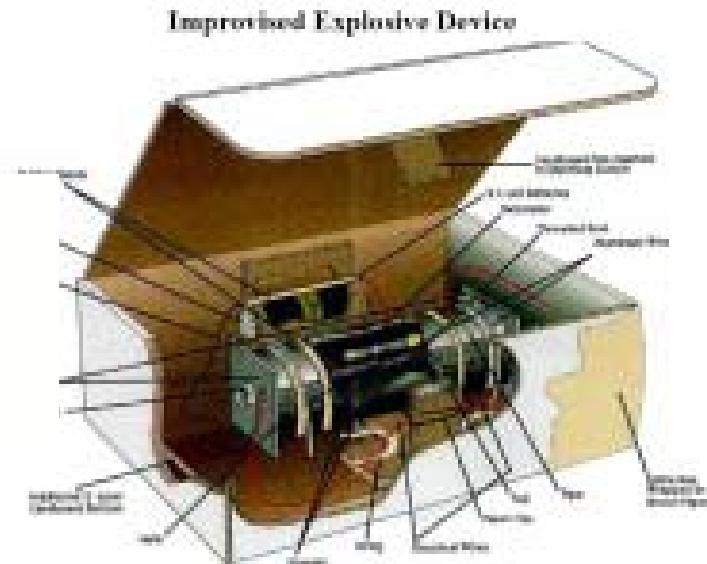



# Characteristics of a Dirty Bomb Incident

- Disperses radioactive contaminated dust into the air and onto surfaces.
- May disperse larger projectiles of either the delivery device (bomb parts) or actual pieces of the radioactive material.
- Most RDDs will use low-level radioactive materials.
- Dispersal of radioactive material may be explosive (active, associated with a bomb) or non-explosive (passive, released into a ventilation system or placed in a waste basket).
- May destroy or damage structures (buildings, infrastructure, utilities, etc).
- Casualties and damage mainly takes place with initial detonation and the short period thereafter. **However low level internal exposures may increase cancer risk.**





## Characteristics of a Dirty Bomb Incident (continued)

- May release other hazardous chemicals by damaging nearby chemical storage containers, creating new chemicals in the explosion, etc.
- Many of the radioactive materials used to make a dirty bomb are also heavy metals which are toxic at low levels.
- Clean up is difficult and costly.
- May include a secondary device (RDD or other agent) with intent to harm responders.



## What is a Secondary Device?

Secondary devices are bombs placed at the scene of an ongoing emergency response. Designed to explode after a primary explosion or other major emergency response event has attracted a large number of responders to the scene, the intent is to inflict injury, damage, and fear among responders.





## Warning Signs of Possible Explosive Materials or Secondary Devices

- Any abandoned container out of place for the surroundings.
- Obvious devices containing blasting caps, timers, booster charges, etc.
- Abandoned vehicles not clearly belonging in the immediate environment.
- Strong chemical odors for which there is no apparent reason.
- Unusual or foreign devices attached to pressurized containers, bulk storage containers or supply pipes.
- Trip wires or other booby traps, suspicious mailing containers.

**Leave all suspicious items alone and report them immediately!**



## Module 2

Dirty Bomb (RDD)  
Radioactivity Basics





## Radioactive Hazards: After an RDD Explodes

- The dispersion of radioactive material will depend on many factors; primarily the physical form of the radioactive material.
- The majority of material will likely be dispersed over a large area as radioactive dust.
- The greatest amount of dust will settle close to the explosion but small amounts can travel large distances, especially small particles.
- Large pieces of radioactive material can be thrown and emit significant radiation



**Hammer RDD simulation  
winter 2007**



## Radioactive Material Defined

- Radioactive material is material that is unstable and spontaneously emits radiation.
- Radioactive material can be dispersed in the form of dust (i.e., from an explosion). This dust will contaminate what it lands on and will contaminate your lungs if you breath it in.
- Examples of radioactive material:
  - Potassium 40 (found in bananas)
  - Cobalt 57 (a radioactive material that is used in lab experiments)
  - Radon (the radioactive gas that may seep into your basements)

**Radiation released from radioactive material does not have a smell or taste and cannot be seen.**



## Examples of Radioactive Materials in Everyday Items



Bananas with potassium 40



1970's tape dispenser with thorium sand



Fiesta Ware with uranium paint



Exit signs with tritium



Lantern mantles with thorium



Smoke detectors with americium



## RDD Radiation Exposure

Radiation exposure to skilled support workers will come from:

- radioactive dust
- large pieces of the bomb's radioactive materials.

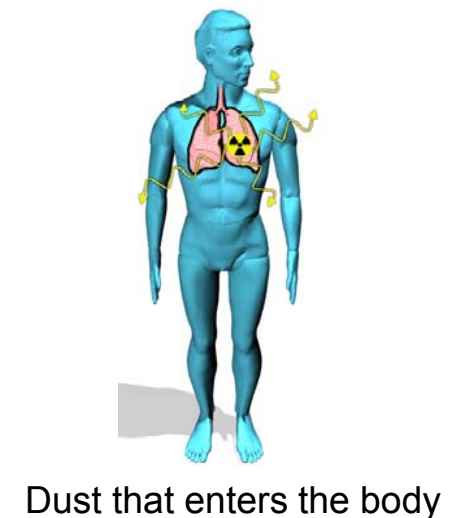
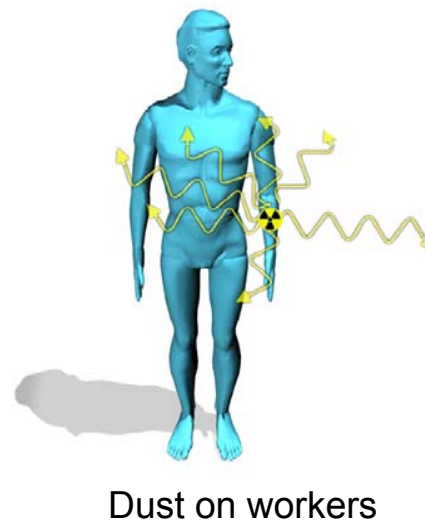
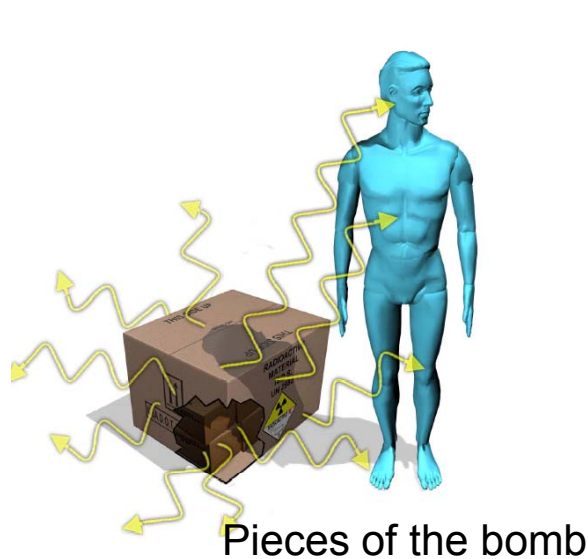





## Contamination and Exposure

- Contamination takes place when contact is made with radioactive material and it is deposited on the skin, clothing, surfaces, etc.
- Exposure to radiation occurs when a person or an object is close enough to radioactive material to be affected by it without touching it.

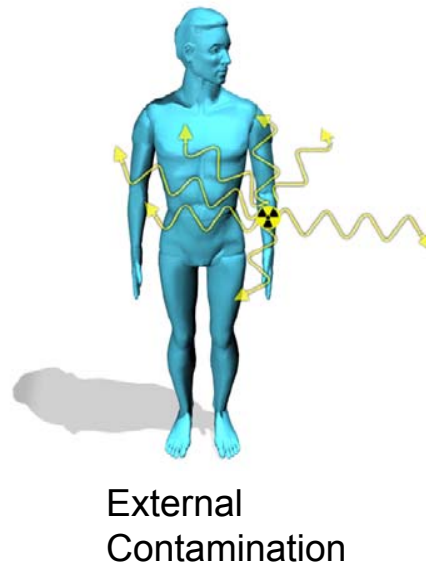
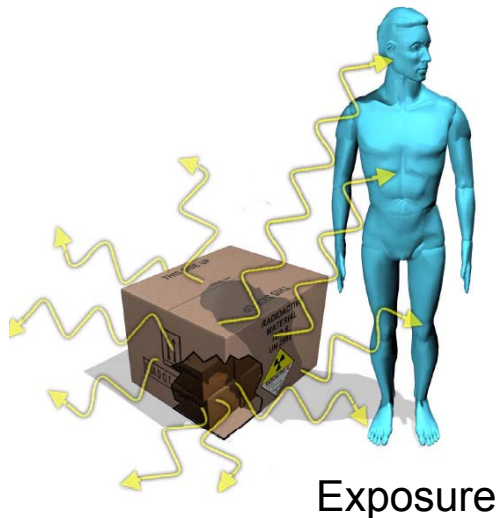



## Contamination and Exposure (continued)

- If radioactive contamination gets onto your clothes, intact skin or surfaces it can be removed through decontamination procedures. (See Module 3.)
- If radioactive contamination gets into your body through inhalation (lungs), digestive system (through eating or mucus) or goes directly into your blood stream (through a cut) it becomes an internal contamination hazard and may lead to high exposure.



## What is Radiation?

- Radiation is energy in motion.
- Radiation may be in the form of particles or rays/waves.
- There are two types of radiation:
  - Non-ionizing radiation
  - Ionizing radiation



**For a dirty bomb response we are most concerned about ionizing radiation**



## The Radiation Spectrum

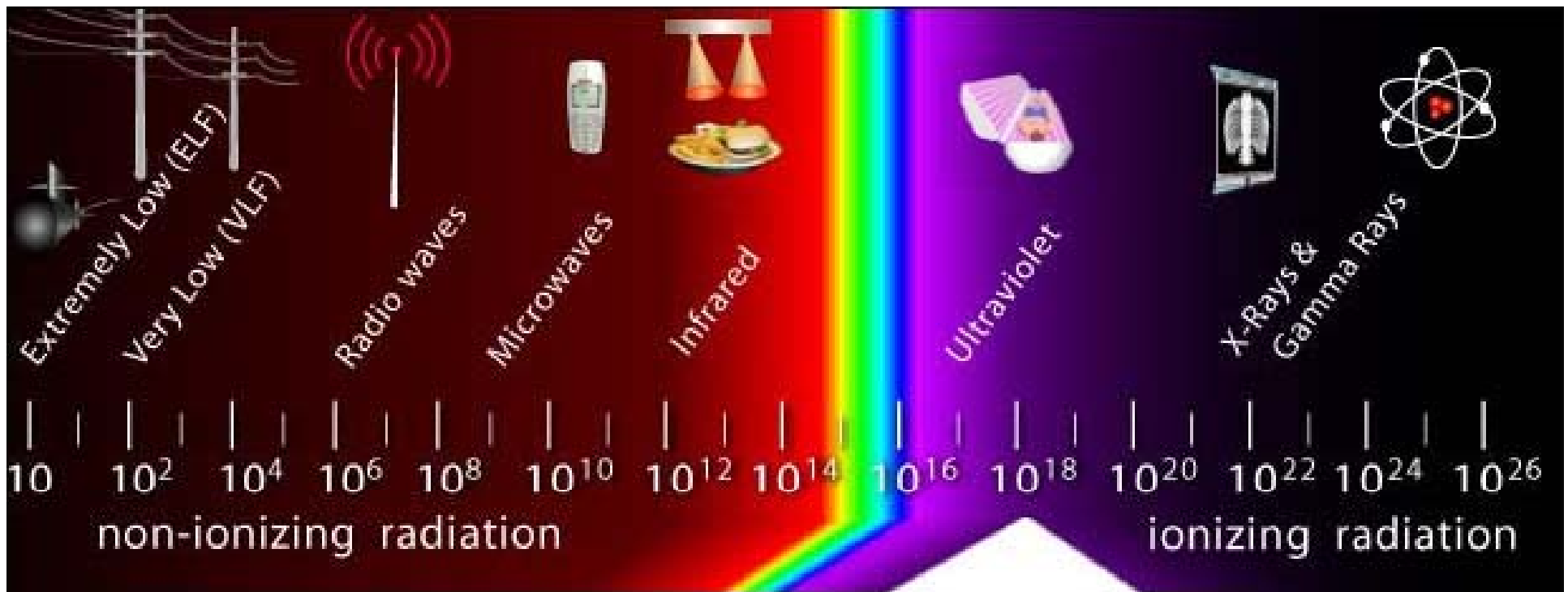

Scale =  $\mu\text{m}$



## How Can I Protect Myself?

- Prevent inhalation or ingestion of radioactive dust or deposition of radioactive dust on skin or a wound.
- Use the Hierarchy of Controls:
  - Eliminate the hazard (leave the area)
  - Engineer the hazard out (use wet methods to control dust)
  - Administrative (use standard operating procedures (SOPs))
  - Personal Protective Equipment (PPE) (i.e., respirators)



## How Can I Protect Myself? (continued)

- Avoid areas with radioactive contamination.
- Decontaminate yourself in accordance with your site decontamination plan.
- Use radiation detection devices.
- Time, Distance and Shielding.

**Note: Time, distance and shielding may not relate to internal radiation hazards.**

**Determine whether you are exposed to the dust, pieces of the bomb, or both.**



## How Can I Protect Myself - Dust

- Dust can be both contamination on your skin or contamination breathed or ingested into your body.
- Ensure that all measures are taken to minimize dust generation (use wet methods, etc.)
- As a final step, wear the appropriate respirator to avoid inhaling dust and protective outer clothing to prevent skin contamination.
- After exposure, take all steps to remove dust.



## How Can I Protect Myself – Bomb Fragments

**The detonation of an RDD may produce larger fragments in the form of shrapnel.**

- Larger pieces may have a higher associated radiological hazard than the dust created from an RDD explosion.
- If you are not certain whether or not a piece of material is radioactive, leave it alone and report it so it can be tested. **Do not handle suspect material.**
- Do not remove shrapnel from a wound unless you are medically qualified to do so. The hazard from radiation will probably be less than the hazard of improperly removing shrapnel. Seek medical attention.





## More on Time

- Limit your exposure to the radioactive source.
- By limiting your time, you limit your dose.





## More on Distance – STAND BACK!

- By increasing the distance between you and the radioactive material you will reduce your dose-rate.
- In fact, if you double your distance from the source, you will reduce your dose-rate to one-fourth.





## More on Shielding

Penetrating Powers of Alpha Particles, Beta Particles, Gamma and X-Rays

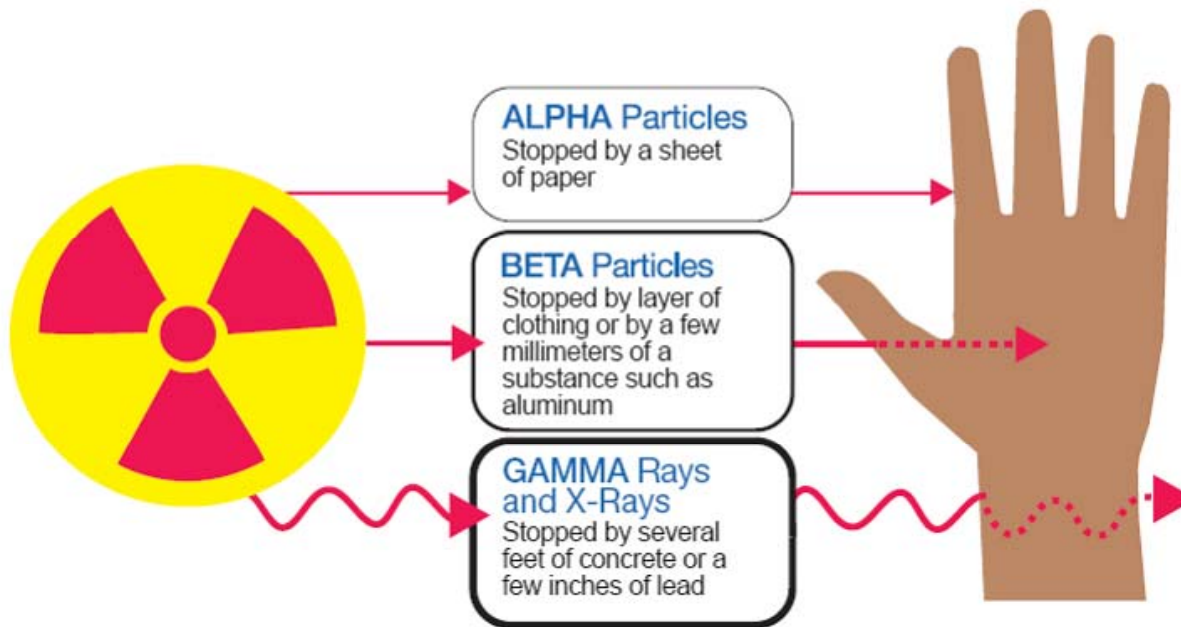



## Units to Measure Ionizing Radiation

- **The following are units used to measure radiation dose. These are some of the terms you might hear on site:**
  - **Rad** - Units for absorbed doses of all radiation
  - **Roentgen** - Units of exposure to gamma radiation
  - **Rem (mrem)** - Unit of dose related to biological risk

**Note: 1000 mrem = 1 rem**



## Radiation Dose vs. Dose Rate

- Radiation Dose (cumulative):
  - The amount of radiation energy deposited in the body
  - Often measured in millirem
- Dose Rate:
  - The rate at which radiation energy is deposited in the body
  - Often measured in millirem per hour



## Radiation Dose

### Acute

- High dose rate
- Short period of exposure
- Visible signs of exposure
  - Nausea
  - Fatigue
  - Hair loss
  - Burns
- Very damaging to tissue
  - Cells have less time to repair
  - Immune system damaged

### Chronic

- Low dose rate
- Long period of exposure
- Less immediately damaging to tissue
- No immediate visible effects
- May cause cancer



## What the Exposure Levels Mean

<b>Health Effect</b>	<b>Dose (rem)</b>
Temporary sterility in testis	15
Nausea	35
Bone marrow depression	20-50
Reversible skin damage	200
Permanent sterility in ovaries	250
Vomiting, fatigue, moderate bone marrow depression	300
Permanent sterility in testis	350
Lethal dose	450 and up



## Atomic Structure

- Atoms consist of:
  - A nucleus (center) made of:
    - Protons (+charge)
    - Neutrons (neutral)
  - Electrons (-charge) orbiting the nucleus.

**For the atom to be stable the number of neutrons must nearly equal the number of protons.**

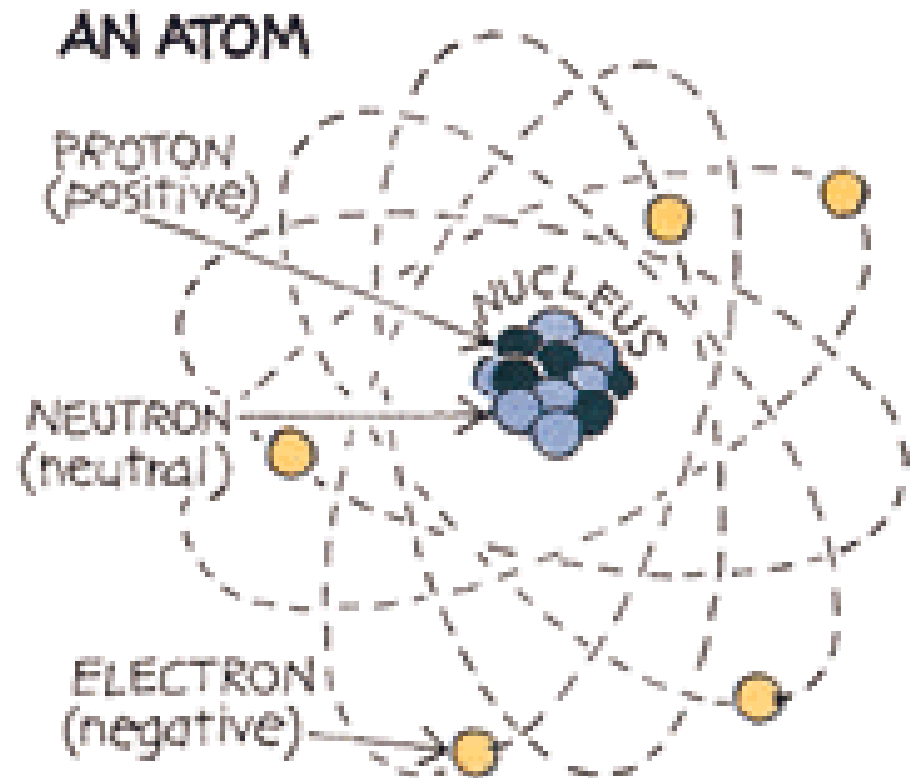





## What Makes an Atom Unstable?

An atom's stability is based on its proton to neutron ratio

- If there are too many or too few neutrons for the number of protons the atom will give off excess energy in the form of:
  - Particles
  - Rays/waves
- This process is called radioactive decay (the release of radiation).

When an atom is unstable it can damage living tissue



## Ionizing Radiation

The energy given off by the nucleus is called **ionizing radiation**

- It is strong enough to detach an electron from an atom.
- When an atom loses an electron, it has a positive charge and is called an **ion**.
- The ion and its lost electron are called an **ion pair**.
- **Ionizing radiation can damage living tissue.**



## How Does Ionizing Radiation Harm Me?

- Destroys cells
- May produce genetic effects
- Affects embryo and fetus
- Increases cancer risk

**Embryo and fetus cells rapidly divide, making them sensitive to ionizing radiation.**

**If you are pregnant, think you are pregnant or are trying to conceive, consult your physician (or other appropriate professional).**



## What is Ionization?

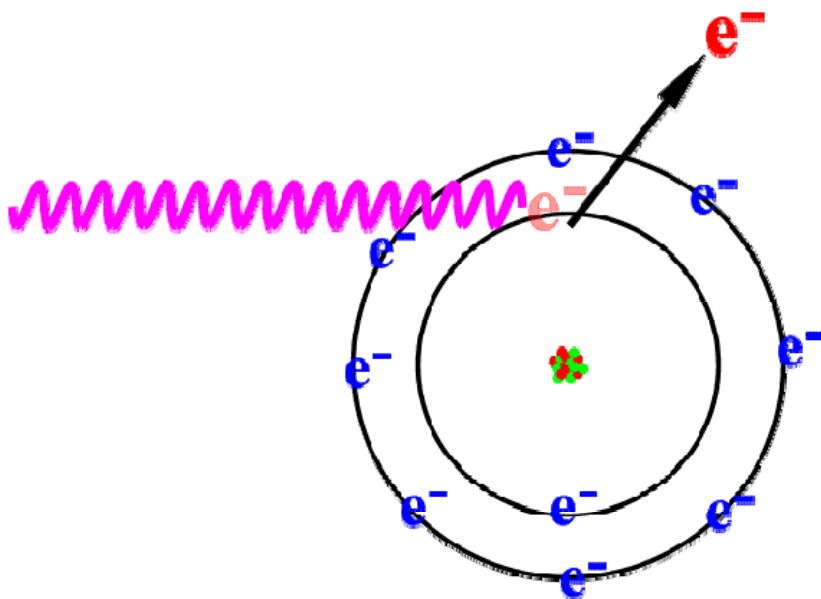

- Ionization occurs when atoms absorb sufficient energy from particle or wave radiation to break their molecular bonds and give off an electron.
- This causes changes or destruction of molecules.
- Ionization can damage living tissue.



## Radiation Basics

- Three types of ionizing radiation we are concerned with are:
  - Alpha ( $\alpha$ )
  - Beta ( $\beta$ )
  - Gamma ( $\gamma$ )

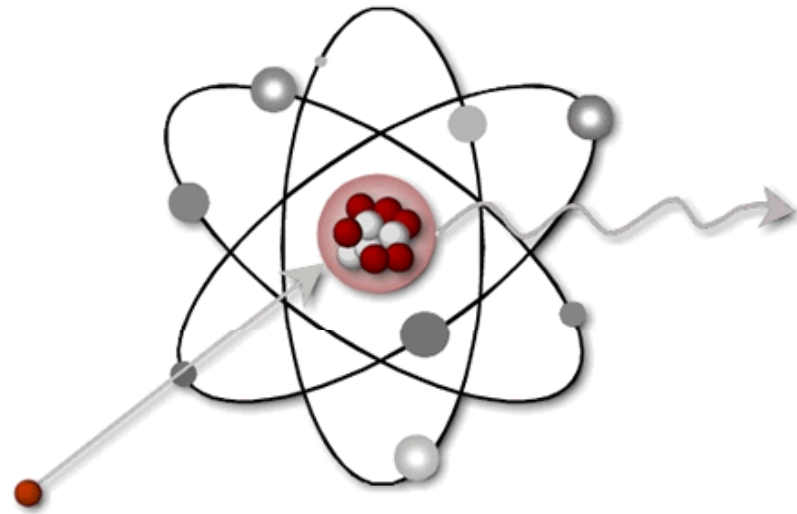

**Of greatest concern with dirty bombs are alpha and beta radiation emitted from inhaled or ingested radioactive contaminated dust.**



## Alpha Radiation

- **Internal hazard:**  
**do not inhale or ingest.**
- Not an external hazard.
- Can cause great biological damage.
- Particle form.
- Travels a few centimeters in air.
- Stopped by a sheet of paper or protective layer of intact skin.

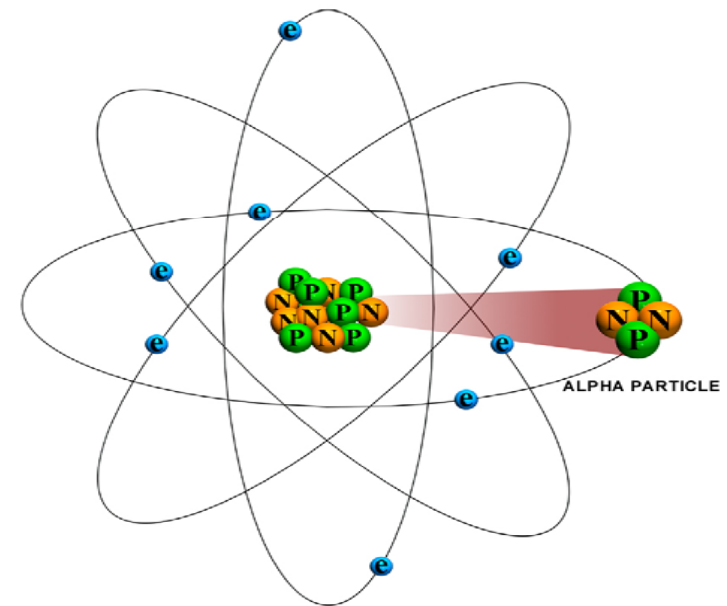



## Beta Radiation

- **External and internal hazard.**
- Particle form.
- Travels 10 - 20 feet in air.
- Shield betas with low density materials such as aluminum or Plexiglas.

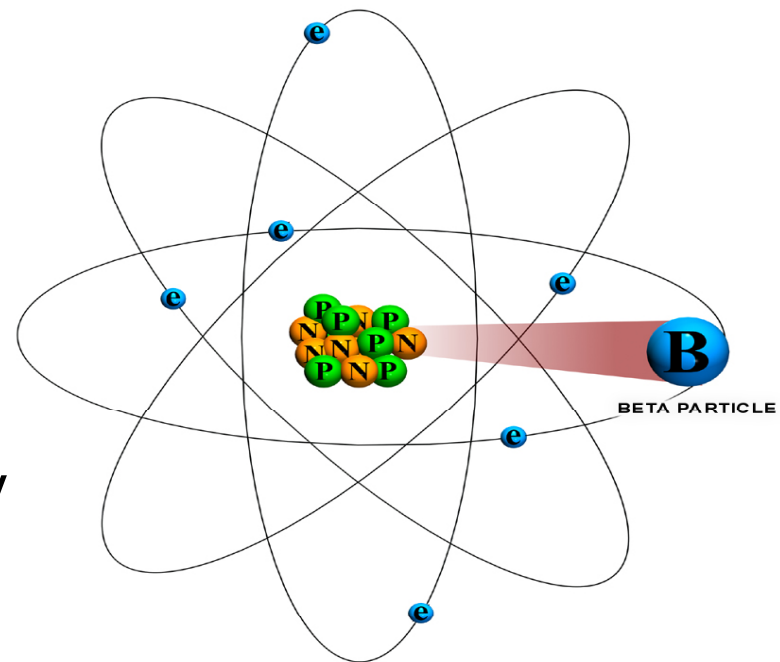



## Gamma Radiation

- **Whole body hazard (internal and external).**
- Wave type of radiation – non-particulate.
- Travel many feet in air.
- Shield with lead or steel.

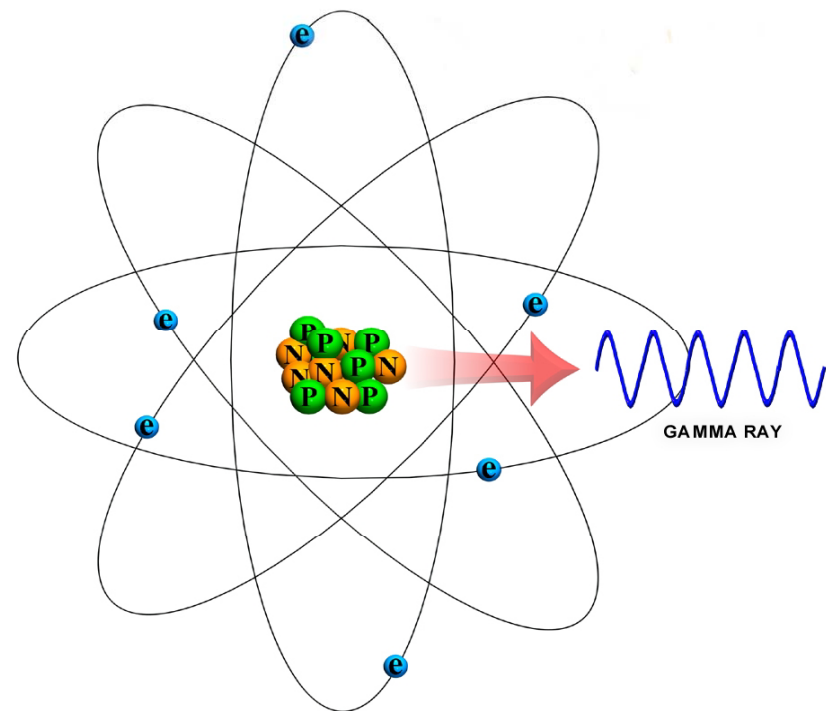





# Where Does “Every Day” Ionizing Radiation Come From?

## Background Radiation

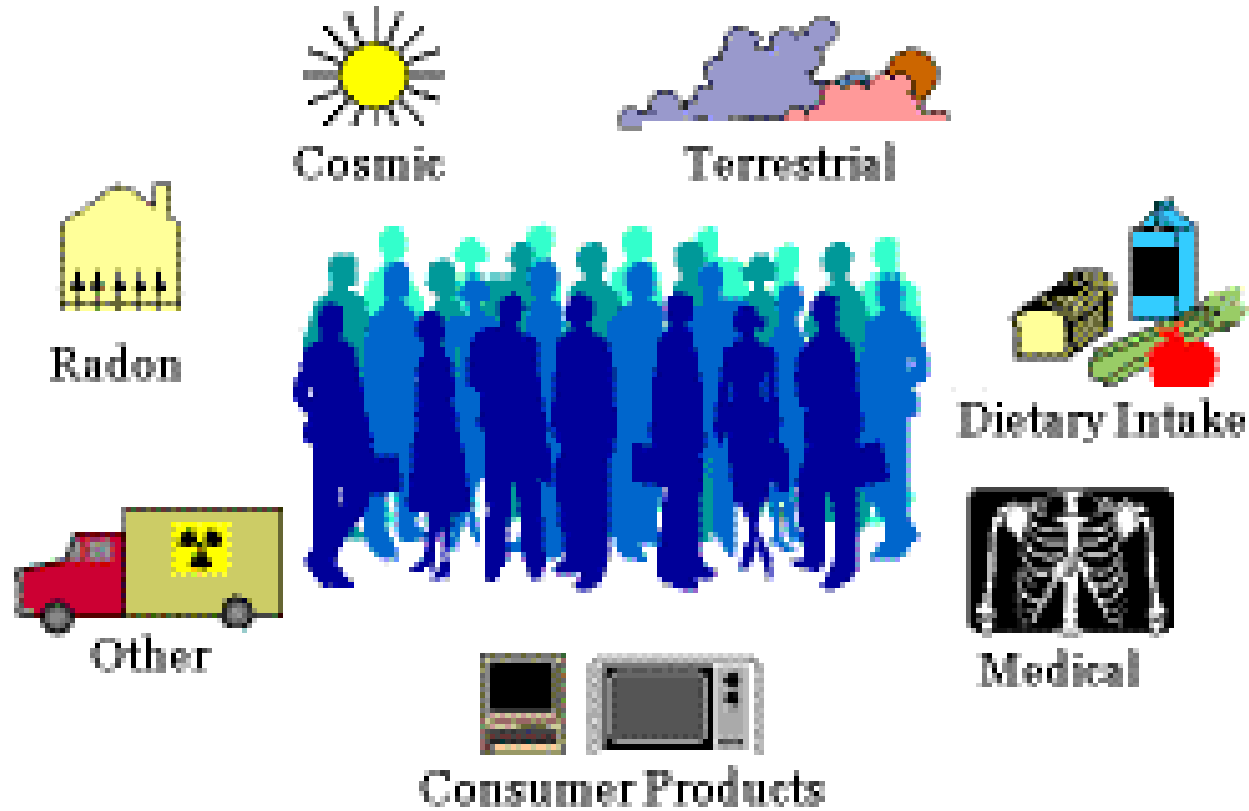



## Types of Ionizing Radiation (summary)

Type	Alpha	Beta	Gamma
Physical Characteristics	Particle	Particle	Ray, Wave
Penetrating Power (Range)	Very Low (1-2" in air)	Low (10-12" in air few mm in skin)	High (several hundred feet in air)
Shielding	1" in air Outer layer of intact dead skin, Clothing	Aluminum Glass Plastic Safety glasses	Concrete Lead Steel Earth berm
Biological Hazard	Internal	Internal, Skin, Eyes, External	Whole body



## Exposure Levels for Ionizing Radiation



### Response Worker:

- 5 rems/year for all occupational exposures (OSHA)
- In addition, the Department of Homeland Security has **voluntary guidelines** for emergency response: Protective Action Guidelines (PAGs) for RDDs and INDs

At PAG levels, you may have acute (immediate) and chronic (gradual, long-term) health effects.

\* 10 rems/year for protecting valuable property

\* 25 rems/year for lifesaving or protection of large populations



## What is the Best Practice?

- ALARA
  - As
  - Low
  - As
  - Reasonably
  - Achievable





## What If I Get Internal Radioactive Exposure?

- There are some medical treatments available that may be used before you receive, or if you receive a high internal exposure of radiation:
  - Potassium Iodide
  - Neupogen
  - Prussian Blue
  - Diethylenetriaminepentaacetate (DTPA)

**You should see a doctor for these treatments. Some treatments have side effects.**





## How Do I Know Radiation is Present?



Radiation detection meter



Direct reading dosimeters



Film badge



Thermoluminescent devices



## Non-ionizing Radiation

- Not a high hazard concern with RDDs
- Energy in motion that is not strong enough to remove an electron from an atom
- Examples of non-ionizing radiation are:
  - Visible light
  - Microwaves
  - Infrared
  - UHF/VHF radio waves



Non-ionizing radiation can be harmful but affects living tissue differently than ionizing radiation.



## Module 3

Controlling hazards during a  
dirty bomb response







## Emergencies in the Field

- Ask what first aid support is available during your briefing and be sure you understand where it is located.
- For minor injuries or health concerns go to:
  - Local hospitals or clinics
  - First Aid, EMT or nurse station
- For serious emergencies call 911.
  - Know your exact location
- Notify your supervisor about all injuries and emergencies.





## National Incident Management System (NIMS)

- NIMS is designed to:
  - provide a framework for incident management
  - “One mission, one team...”
- Used for ALL types of incidents (e.g., mass casualty and planned events).
- First standardized approach to incident management and response.
- Establishes uniform set of procedures to be used by emergency responders at all levels of government to conduct response operations.



## Core Elements of NIMS

- Incident Command System (ICS)
- Preparedness (planning, training, exercises, qualifications and certifications of all personnel involved in incidents)
- Communications and Information Management
- Joint Information System
- National Integration Center, Incident Management Systems Division



## Incident Command System (ICS)

The incident command system will be used to effectively manage emergency situations.

- ICS uses:
  - Unity of command (one person in charge)
  - Span of control to manage personnel (3 - 7 people under one supervisor)
  - Common terms so everyone understands what is being said
  - A modular system to manage resources (a system that can expand and contract with the emergency event)
  - Life safety code





# Incident Command System Structure





## Work Zones

- Exclusion zone (hot zone) - radiation hazard is present and only properly trained and authorized personnel may enter.
- Contamination reduction zone (warm zone) - used to remove contamination from personnel and equipment and includes:
  - Decontamination corridor
  - Emergency decontamination
- Support zone (cold zone) - incident command and other support functions stationed here.

**HAZWOPER and Rad-specific training is required for entry into hot and warm zones on an RDD site.**





## More About Work Zones

- **Setting up work zones will depend on:**
  - Magnitude of ordinance used
  - Radioactive material used
  - Population density
  - Environmental factors: wind direction, day/night, etc.

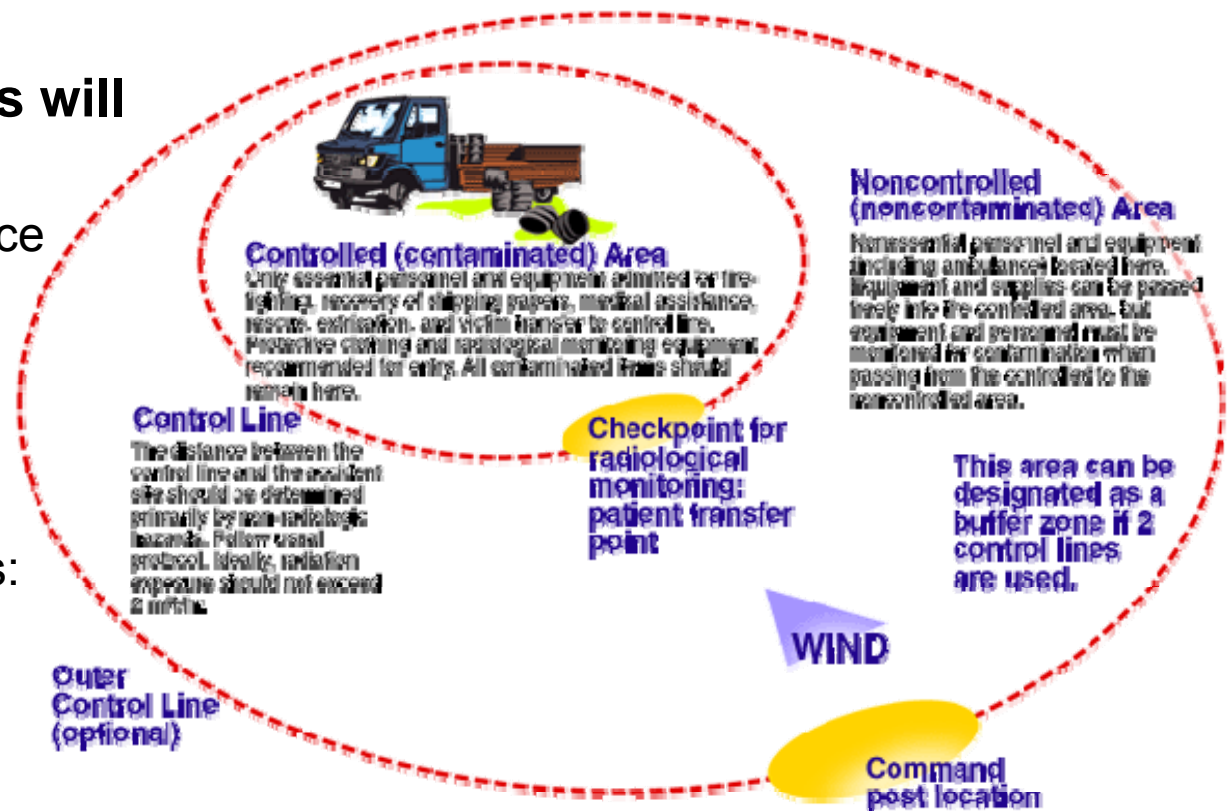



## Health and Safety Plans (HASP)

- OSHA has set regulations that require Health and Safety Plans (HASP) to protect workers involved in national response operations.\* The HASP serves as a guide for employers and workers to follow during their daily operations to prevent the spread of contamination, injury, and death.

\*OSHA, 29 CFR 1910.120, HAZWOPER





## HASP (continued)

This document covers some HASP sections that will be used on the worksites during a dirty bomb response. The site safety section includes general information from several of the HASP sections listed below.

### All HASPs must cover all of the following:

- Introduction
- Key Personnel
- Hazard Assessment
- Training
- PPE
- Temperature Extremes
- Medical Surveillance
- Exposure Monitoring and Air Sampling
- Site Control
- Decontamination
- Emergency Response/Contingency Plan
- Emergency Action Plan
- Confined Space Entry
- Spill Containment



## Personal Protective Equipment (PPE)

**Depending upon your worksite's PPE program and assigned job task, any of the following PPE may be required:**

- Protective suit ranging from standard coveralls to a liquid impermeable splash suit with hood to keep contamination out of hair
- Respirator ranging from an N-95 to a PAPR for high exposure and strenuous work. In rare cases a SCBA may be required (initial response, high levels of heavy metals)



## PPE (continued)

- Protective washable or disposable footwear
- Inner disposable glove and disposable outer cut/abrasive resistant work glove
- Fully enclosed goggles
- Ear protection in noisy areas
- Head protection if in construction or demolition zones
- Be sure to follow your worksite's PPE program

**The OSHA PPE standard (29 CFR 1910 Subpart I) must be followed when selecting and using PPE.**



## PPE Examples



Safety glasses



Safety Goggles

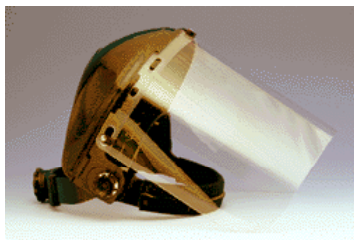

Face Shield



Level C PPE with tyvek splash suit and APR respirators



Example of Leather gloves  
Courtesy Kirkwood



Example of Nitrile gloves  
Courtesy Kirkwood

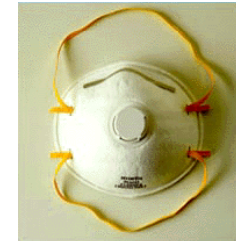

N-95 respirator



1/2 face APR



Full face APR



PAPR



## Decontamination

- Decontamination or Decon is the process of removing, destroying, or reducing the activity of materials such as toxic chemicals or radioactive contamination that could endanger an individual or the environment. Decontamination of personnel is necessary to keep the radiation from spreading to other locations.
- In the event of a dirty bomb the heaviest contamination will occur:
  - Within the immediate blast area of the detonated device or area of dispersion
  - Handling contaminated people or property near the dispersion





# Decontamination (continued)

A decontamination plan should include:

- Training
- Location and layout of decontamination stations and areas
- Decontamination methods
- Required decontamination equipment
- Standard Operating Procedures (SOPs) to minimize worker contact with contamination during decontamination
- SOPs for decontamination line personnel
- Procedures for collection, storage and disposal of clothing equipment and any other materials that have not been completely decontaminated
- Procedures to dispose of PPE and decon solutions as contaminated waste
- Adequate personal washing stations
- Post-radiation detection station to ensure contamination is removed to acceptable levels



## Decontamination (continued)

- Site workers who use the site's SOPs are less likely to be contaminated than site workers who do not use these practices. Workers can take steps to minimize their exposure during decontamination through using contact minimization techniques such as:



- Remote handling techniques which reduce hand-to-material contact such as using shovels, wheelbarrows, Bobcats, etc.
- Avoiding handling sharp debris since external radiation can become an internal hazard through punctured skin.
- Wearing an outer layer of disposable clothing (PPE).
- Encasing tools/equipment in plastic (i.e. place sampling equipment in a plastic bag).



## Decontaminating an Injury

- If you have a cut or punctured skin take precautions to prevent radioactive external contamination from becoming a radioactive internal exposure hazard:
  - Seek qualified medical treatment
  - Do not abrade the skin or wound
  - Do not force decon solution into the wound (this will direct radioactive contamination into the body!)
  - Direct decon solution to flow away from the wound by using gravity



Photo from REACTS decon tool





## Decontaminating an Injury (continued)

- Survey the wound before and after decon has been performed to determine the level of contamination reduction



Photo from REACTS decon tool

For further information on decontaminating a wound go to:  
<http://orise.orau.gov/reacts/guide/procedures.htm>



## Further Steps to Reduce Radiation Internal Exposure

- Do not eat, drink or smoke in a radiation controlled area (warm or hot zone).
- Only eat, drink or smoke in authorized areas after you have been properly decontaminated.
- Wash hands and face frequently when not in work areas.
- While working the incident only eat and drink what is provided there.



## Prevent the Spread of Radioactive Contamination to Your Family and Home

- Bringing home contaminated work clothes or equipment may contaminate your home and place your family at risk.
- Bring a clean change of clothes to the worksite.
- Wash work clothes separately. Preferably in a employer provided location.



## General Safety Tips

- Be careful and use safety measures outlined in your worksite's HASP at all times.
- This is a crime scene; be on the lookout for additional destructive devices.
- Walking/working surfaces may be wet, slippery and unstable. Spread sand and wear slip resistant footwear if possible, to reduce slips and falls.





### General Safety Tips (continued)

- Walking over and handling debris that is unstable can cause cuts, scrapes, bruises, sprains, etc.
- Make sure you have had a current tetanus vaccination.
  - Revaccinate for a dirty wound if current vaccination is over 5 years old.
  - If you will be performing direct patient care or otherwise expect to have contact with bodily fluids, get the Hepatitis B vaccine series.
- Avoid contact with stagnant water.
  - If exposed to stagnant water, wash and decontaminate yourself and any contaminated equipment immediately.
- Use steel toe/shank non-slip footwear if available.
- Use durable outer gloves when handling debris.
- Wear ear protection for noisy environments.



## Bloodborne Hazards

- Use latex or similar gloves when handling human remains or assisting those with injuries.
- Replace gloves if punctured or torn.
- Do not handle human remains if you have skin cuts or punctures.
- Use goggles or face shield and mask for handling human remains, recovering deceased. Make sure to cover your nose and mouth.
- Transport human remains in closed, leak-proof, labeled containers.
- Remember, remains may be contaminated with radioactive material.



**OSHA Blood Borne Pathogen Standard:  
29 CFR 1910.1030**



## Chemical Hazards and the Hazcom Standard

- There may be a release of hazardous chemicals from the detonation device or from a secondary device.
- The material that forms the dust during an RDD release may also be toxic (i.e. many radioactive materials are also heavy metals).
- Specific Hazard Communication training is required for any potential chemicals that you may come in contact with.
- Understand how to locate, read and apply information in Material Safety Data Sheets (MSDS). MSDS provide both workers and emergency personnel with the proper procedures for handling or working with a particular substance.



## Carbon Monoxide (CO) Exposure

**Carbon Monoxide has no warning properties; it is a colorless odorless gas!**

Symptoms: Headache, dizziness, drowsiness, or nausea; progressing to vomiting, loss of consciousness. Prolonged or high exposure can lead to coma or death. Worksites that have a high risk for CO exposure include:

- **Any activity using gasoline or propane-powered machinery**
- **Near operating equipment**
- **Near generators**
- **Debris reduction sites**
- **Near hot work (cutting, welding) especially in confined spaces**







## Excavation Hazards

**Search and Rescue or structural repair operations may require excavation.**

- Excavations can create many hazards which must be controlled to safely work around and in them.
- An excavation is any man-made cut, hole, trench, or depression in the earth formed by earth removal.
- A trench is defined as a narrow below-ground excavation that is deeper than it is wide, and is no wider than 15 feet.



## Excavation Hazards (continued)

- The following are potential excavation hazards:
  - Cave in
  - Falls; falling loads
  - Hazardous atmosphere
  - Incidents involving mobile equipment
- A competent person must evaluate soil for excavation safety. All excavations/trenches should have safe means for entering and exiting (ladders, safe design, etc.). **DO NOT** enter an unsafe excavation!



### Excavation Hazards (continued)

- If an excavation is over 4 feet deep, an egress (emergency exit route/device i.e. ladder) must be provided which may not be the sides of the excavation.
- Distance to egress must be 25 feet or less.
- If an excavation is five feet deep or more, one of the following engineering controls must be used:
  - Shoring
  - Shielding
  - Sloping
  - Movement of overloaded or unusual vehicles, oversized loads, and heavy operating equipment

**See OSHA's Trenching and Excavation Factsheet**



## Controlling Excavation Hazards

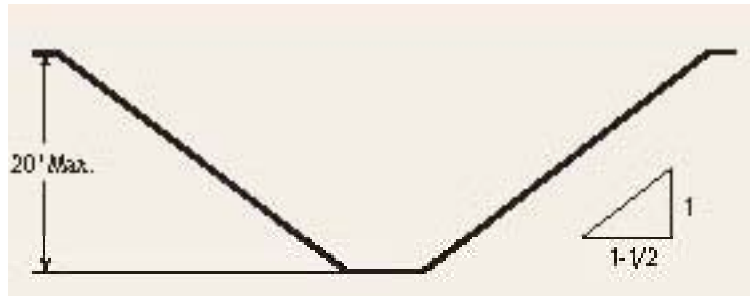

Sloping in type C soil

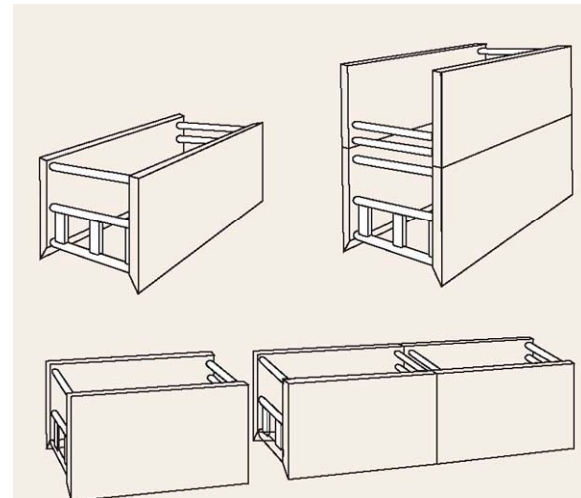

Shielding

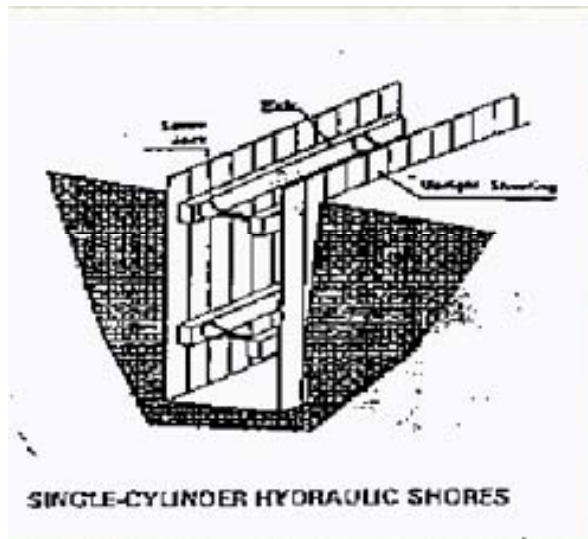

Shoring



## Excavation Hazards (continued)<sup>1</sup>

### General Trenching and Excavation Rules

- Keep heavy equipment away from trench edges.
- Keep surcharge loads at least 2 feet (0.6 meters) from trench edges.
- Know where underground utilities are located.
- Test for low oxygen, hazardous fumes and toxic gases.
- Inspect trenches at the start of each shift.
- Inspect trenches following a rainstorm.
- Do not work under raised loads.

<sup>1</sup>. OSHA Trenching and Excavation Factsheet



## Confined Spaces

What is a Confined Space?

- Space with limited access
- Large enough for bodily entry
- Not designed for occupancy
- Example: sewers/storm drains



What are the hazards?

- Oxygen deficiency
- Entrapment
- Engulfment
- Hazardous atmosphere



**Your Safety Officer Must Approve Confined Space Entry!**



## Confined Spaces (continued)

### **Before you enter a confined space your supervisor must:**

- Make sure you and the attendant are trained.
- Ventilate and monitor for hazardous atmosphere.
- Lock out or tag out all power equipment in the space.
- Issue appropriate PPE, possibly including self-contained breathing apparatus (SCBA).
- Establish barriers to external traffic such as vehicles and pedestrians.
- Provide ladders or similar equipment for safe entry and exit in the space.
- Provide good communications equipment and alarm systems.
- Have rescue equipment and trained rescue personnel nearby.



## Structural Integrity

- OSHA requires walls or floor to be shored or braced before demolition if workers are within structure. Cut off, cap or control all service utility lines outside the building before demolition work is started. Notify appropriate utility company in advance.
- If it is necessary to maintain any utilities during demolition, such lines shall be temporarily relocated and protected.
- Determine if any hazardous substances have been on the property. Remove any found hazardous substance before demolition.
- Do not cut or remove any structural or load-supporting members on any floor until all stories above such a floor have been demolished and removed.







## Flying Debris and Material Handling

- Wear personal protective equipment, including hard hats, safety shoes, eye glasses, and work gloves.
- Do not walk under or through areas where cranes and other heavy equipment are being used to lift objects.
- Make sure that you have an up-to-date tetanus immunization.



## Debris Piles and Unstable Surfaces

- Only walk on surfaces you know are stable.
- Use other ways to get to work surfaces, such as bucket trucks.
- Erect scaffolding and park lift equipment on stable surfaces and anchor it to stable structures.
- Wear protective equipment provided, including safety shoes with slip resistant soles.
- Use fall protection with lifelines tied off to suitable anchorage points, including bucket trucks, whenever possible.



# Aerial Lifts

**Vehicle-mounted devices used to get a worker to an elevated position, (also called “cherry pickers” or “boom trucks”).**

- Only trained and authorized people may operate the lift.
- Read and understand the safety and operating instructions including all warning decals or labels.
- Check for overhead objects before use.
- Stay far from debris piles, drop-offs, and floor openings.
- Never use near electric lines unless they are deenergized or adequate clearance is maintained.
- Refuel tanks only when the unit is off and charge batteries in a well ventilated area away from open flames.
- Elevate the lift only when it is on a firm and level surface.
- Whenever working out of an aerial, a full body harness must be worn and properly attached to the basket.
- Never drive the aerial lift when it is elevated above the limit the manufacturer considers safe.



## Falls from Heights Six Feet and Higher

- Employees shall be protected from falls greater than six feet to a lower level.
  - Guardrail Systems
  - Safety Net Systems
  - Fall Arrest Systems (less effective than guardrail and safety net systems)
  - Cover or guard any openings or floor holes as soon as they are created.
  - Make sure floor hole covers support two times the weight of employees, equipment, and materials
  - Be careful when stepping into areas that are unstable/uneven or where the surface cannot be visualized (i.e., areas covered by water).
- Workers should prevent items from falling onto people below.

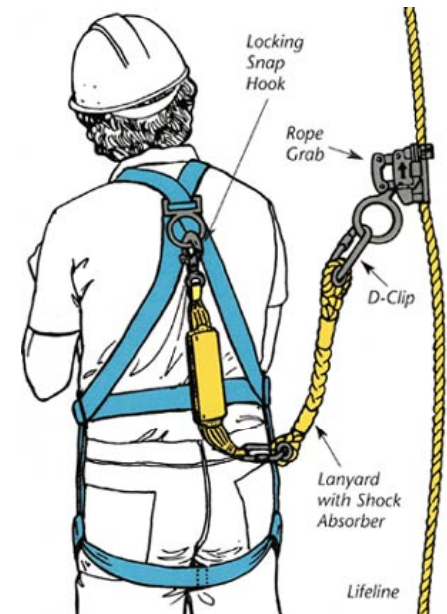



## Ladder Safety

**Ladders can create a falling hazard. Make sure your ladder is secure:**

- Position portable ladders so the side rails extend at least 3 feet above the landing.
- Secure side rails at the top to a rigid support and use a grab device when 3 foot extension is not possible.
- Do not apply more weight on the ladder than it is designed to support and make sure that the weight on the ladder will not cause it to slip off its support.
- Before each use, inspect ladders for cracked, broken, or defective parts.
- Use only ladders that comply with OSHA standards.

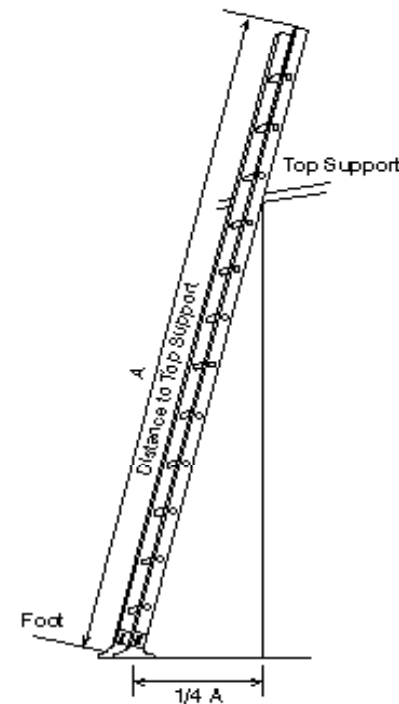



## Electrical Hazards

- Electrocution is a common safety hazard on many worksites.
- Avoid working with electricity in wet environments. If this must be done, use electrical cords approved for wet conditions.
- Electrical cords and plugs must meet OSHA standards.
- Use double insulated tools. Check the Underwriter's Label to be sure the tool is double insulated.
- Use Ground Fault Circuit Interrupters (GFCIs) on all power tools and cords as close to the panel as possible.



Portable GFCI.



## Electrical, Overhead Power Lines, Downed Electrical Wires, Cables

- Treat all power lines and cables as energized until proven otherwise.
- Use appropriately grounded low-voltage equipment.
- Stay clear of downed electrical lines.





## Hazardous Utilities

- Look for overhead power lines and buried power line indicators. Post warning signs.
- Contact utilities for buried power line locations.
- Stay at least 10 feet away from overhead power lines.
- Unless you know otherwise, assume that overhead lines are energized.
- Get the owner or operator of the lines to de-energize and ground lines when working near them.
- Other protective measures include guarding or insulating the lines.
- Use non-conductive wood or fiberglass ladders when working near power lines.





## Driving and Traffic Issues

- Worksites must be posted with legible traffic signs at points of hazard. Flag persons or Flagger are used when signs, signals, and barricades do not provide adequate protection for workers. Traffic issues workers may experience include:
  - Heavy traffic
  - Inexperienced or poor drivers





## Heavy Equipment Use

- OSHA requires machinery to be inspected by a qualified worker before each use.
- Be alert to the activities around you.
- Do not exceed the load capacity of lifting equipment.
- Do not walk under or through areas where heavy equipment are lifting objects.
- Do not climb onto or ride loads being lifted or moved. Do not ride on equipment or in bucket.





## Heavy Equipment Use (continued)

The following are the types of heavy equipment that may be used during a dirty bomb response:

- Front End Loaders
- Forklifts
- Bobcats
- Tractors
- Cranes
- Trailers
- Articulated Trucks





## Debris Removal Equipment



### Hazards include:

- Overhead power lines
- Traffic
- Congested – bottle neck area
- Worker on top of potentially unstable load
- Modified trailer used to haul oversized load debris
- No traffic control (direction)



## Hand and Portable Power Tools

All workers should be trained on the tools they use.

### Hand Tools

- Inspect tools in accordance with manufacturers specifications.
- Take damaged tools out of service.
- Use only sharp tools.



### Portable Power Tools

- Inspect tools in accordance with manufacturers specifications.
- Use with sharp blades
- Use with GFCI
- Use with proper gauge electric cord
- Use double insulated tools.
- Always wear eye protection



# Heat Stress



**Common signs and symptoms workers experience if they have any of these conditions.**

<u>Heat Stress</u>	<u>Heat Exhaustion</u>	<u>Heat Stroke</u>
Headache	Headache	Headache
Thirst	Dizziness	Dizziness
Profuse sweating	Confusion	Restlessness
Muscle aches	Nausea	Confusion
	Sweating-pale, clammy skin	Hot, flushed dry skin
	Cramps, legs & abdomen	Body temp above 104° F
	Rapid, weakening pulse & breathing	Unresponsive/disoriented



## Heat Stress (continued)

- Drink when thirsty.
- Know the signs of heat-related illnesses.
- Monitor yourself and coworkers, use the buddy-system.
- Block out direct sun or other heat sources.
- Use cooling fans/air-conditioning and rest regularly.
- Wear lightweight, light-colored, loose-fitting clothes and a hat if available. Avoid alcohol, caffeinated drinks, or heavy meals.
- Get medical help for symptoms such as altered vital signs, confusion, profuse sweating, excessive fatigue, or rapid heartbeat.
- Take shelter in shaded areas. Fire fighters should unbutton and remove bunker gear.



## Noise Exposure

- Wear appropriate hearing protection in noisy work environments.
  - Examples: power saws, earth-moving equipment, pneumatic tools.
- A worksite is considered noisy if you have to shout to be heard within three feet.



Ear plugs



Ear muffs





## Traumatic Stress

- A traumatic event is a shocking and emotionally overwhelming situation in which an individual perceives actual or threatened death or serious injury.
- Workers responding to a dirty bomb incident may experience traumatic stress.
- Reactions to traumatic events will vary, ranging from relatively mild to severe.
- It is very common for people to experience anxiety, terror, shock, and upset, as well as emotional numbness and personal or social disconnection.<sup>1</sup>



**Pay attention to co-workers and how they are being affected by traumatic stress**

<sup>1</sup> International Society For Traumatic Stress Studies



## Traumatic Stress (continued)

### **Symptoms and negative effects of Traumatic Stress include:**

- Physical illness (headaches, fatigue)
- Inability to function normally on the job
- Depression
- Anxiety
- Making efforts to avoid reminders of a traumatic event
- Marital and family conflict
- Hostility and aggression
- Death through suicide as a reaction to overwhelming stress



## How to Cope With Traumatic Stress

**Some useful techniques to reduce stress when participating in a response are:**

- Take a break from the news
- Pace yourself and take frequent rest breaks
- Watch out for each other
- Be conscious of those around you; responders who are exhausted, feeling stressed, or even temporarily distracted may place themselves and others at risk
- Maintain as normal a schedule as possible
- Drink plenty of fluids such as water and juices

**Individuals with prolonged traumatic stress (anxiety, depression, etc.) that disrupt their daily functioning should consult with a trained and experienced mental health professional.**



### How to Cope With Traumatic Stress (continued)

- Try to eat a variety of foods and increase your intake of complex carbohydrates (breads, muffins made with whole grains)
- Whenever possible, take breaks away from the work area; eat and drink in the cleanest area possible
- Recognize and accept what you cannot change-the chain of command, organizational structure, waiting, equipment failures, etc.
- Talk to people when YOU feel like it; you decide when you want to discuss your experience
- If your employer provides you with formal mental health support, use it
- Give yourself permission to feel rotten; you are in a difficult situation
- Recurring thoughts, dreams, or flashbacks are normal-do not try to fight them; they will decrease over time.
- Communicate with your loved ones at home as frequently as possible



## How to Cope With Traumatic Stress – What You can Do at Home

- Reach out - people really do care.
- Reconnect with family, spiritual, and community supports.
- Consider keeping a journal.
- Do not make any big life decisions.
- Make as many daily decisions as possible to give yourself a feeling of control over your life.
- Spend time with others or alone doing things you enjoy to refresh and recharge yourself.
- Be aware that you may feel particularly fearful for your family; this is normal and will pass in time.
- Remember that "getting back to normal" takes time. Gradually work back into your routine. Let others carry more weight for a while at home and at work.



### How to Cope With Traumatic Stress – What You can do at Home (continued)

- Be aware that recovery is not a straight path but a matter of two steps forward and one back. You will make progress.
- Appreciate a sense of humor in yourself and others. It is OK to laugh again.
- Your family will experience the disaster along with you. You need to support each other. This is a time for patience, understanding, and communication.
- Avoid overuse of drugs or alcohol. You do not need to complicate your situation with a substance abuse problem.
- Get plenty of rest and normal exercise. Eat well balanced, regular meals.



## Protecting Your Family During an RDD Event

Create an emergency response preparedness kit containing:

- Water
- Non-perishable food (at least three days worth)
- First aid supplies
- Medications
- Battery powered radio
- Flashlight
- Tools
- Duct Tape
- Cash/traveler's checks
- Clothing
- Bedding
- Toiletry items
- Special needs items
- Important documents (i.e. birth certificate, passport, etc.)



## Dirty Bomb Activity

- If possible, conduct table top or group activities to enhance learning and training experience.
- Activity can vary in time depending on training objectives, class size, class experience, etc.
- Make activity “real world” and specific to audience.



**Hammer Rad worker training**





# Summary

- Proper training is a key component of a safe response.
- Radioactive contamination (dust) is the main hazard.
- The hazards and issues covered in this training tool are dynamic and require vigilance and flexibility.
- The key to a safe response is attention to the safety issues of your work environment.
- In addition to the similar physical hazards of a construction or demolition site, there is the added factor of radiological contamination, threat of secondary devices and potential release of hazardous chemicals.



## Information Sources

**This training tool is based on recommendations from:**

- U.S. Department of Homeland Security (DHS)
- Department of Energy (DOE)
- National Institute for Environmental Health Sciences (NIEHS)
- National Council on Radiation Protection and Measurements (NCRP)
- National Institute for Occupational Safety and Health (NIOSH)
- Occupational Safety and Health Administration (OSHA)
- Center for Disease Control and Prevention (CDC)
- Environmental Protection Agency (EPA)
- International Atomic Energy Agency (IAEA)

Factsheets from these agencies and other RDD preparedness resources are available on the NIEHS National Clearinghouse for Worker Safety and Health Training website, <http://tools.niehs.nih.gov/wetp>.



## Why This Training Tool Was Created

This training tool was created by the NIEHS National Clearinghouse for Worker Safety and Health Training under contract no. 273-05-C-0017 from the National Institute for Environmental Health Sciences Worker Education and Training Program (WETP). WETP has trained over a million emergency responders and hazardous waste workers since 1987 to do their jobs safely. WETP is a part of the Department of Health and Human Services, which is a cooperating agency under the Worker Safety and Health Support Annex of the National Response Plan. As part of the coordinated effort, WETP created this training tool for those who may be involved in a response to an RDD.

